

PROPOSED CONCEPT PLAN FOR CAMP ROAD SIDEWALK IMPROVEMENTS TOWN OF JAMES ISLAND

TYPICAL SECTION 1 ***EXISTING GROUND SLOPES AWAY FROM CAMP ROAD***

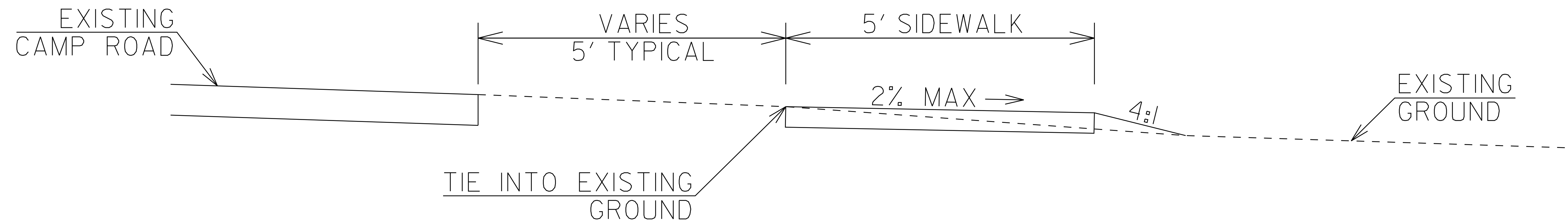

TYPICAL SECTION 2 ***EXISTING GROUND SLOPES TOWARD CAMP ROAD***

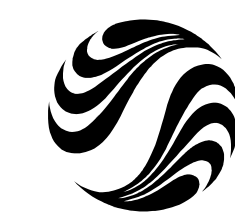
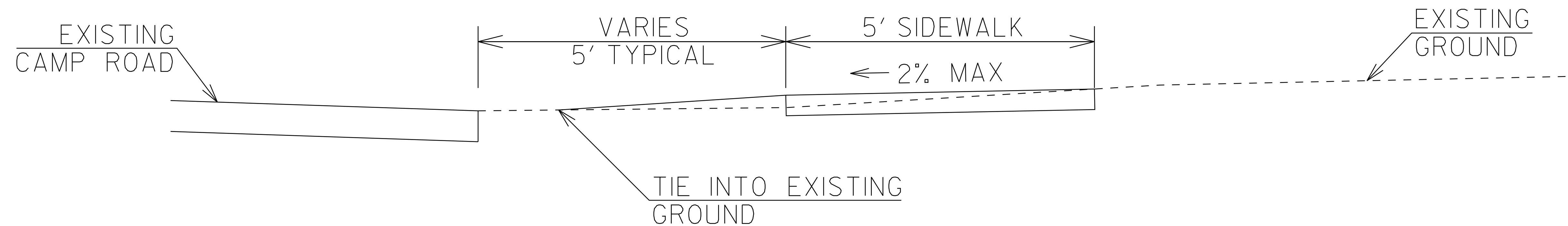

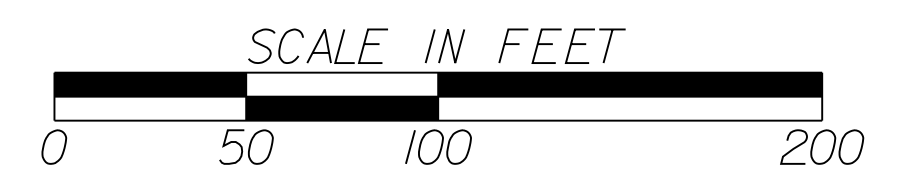
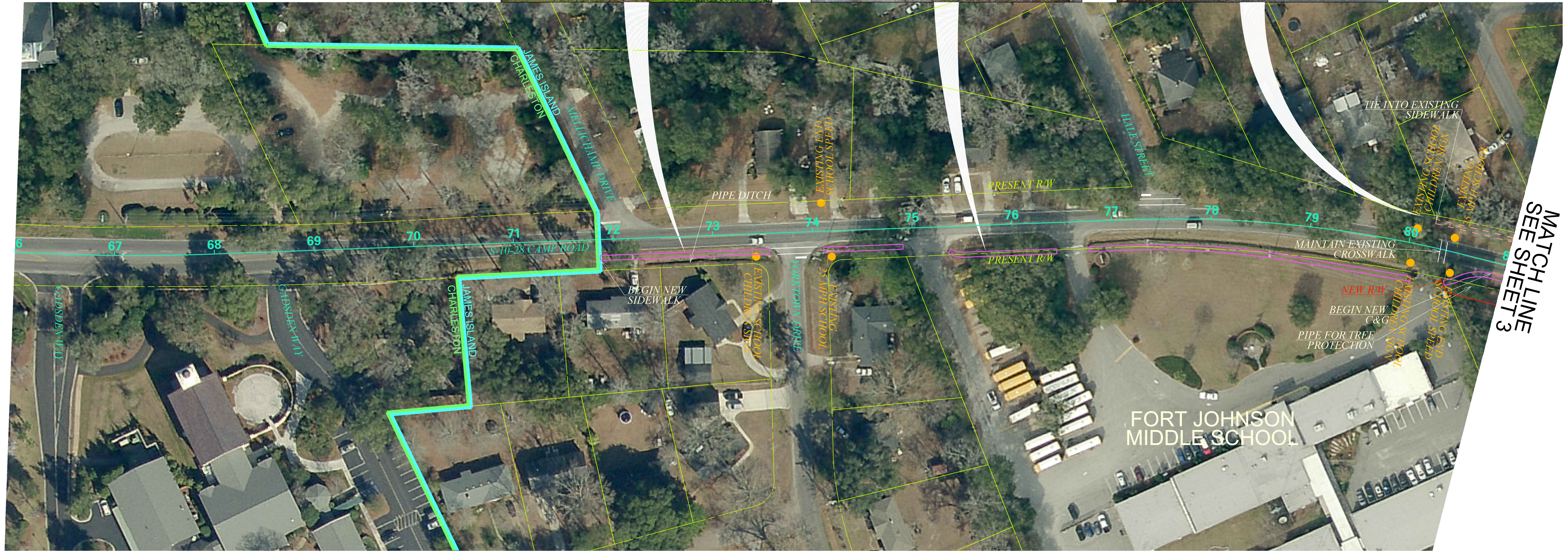
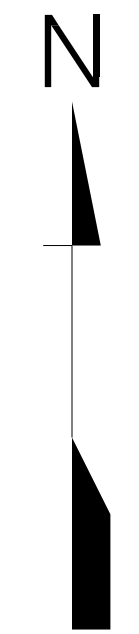

PLANS PREPARED BY:



Stantec Consulting
 4969 Centre Pointe Drive, Suite 200
 North Charleston, SC 29418
 Tel. 843.740.7700
 Fax. 843.740.7707
 www.stantec.com

4			
3			
2			
1			
REV. NO.	BY	DATE	DESCRIPTION OF REVISION
TOPO.		DATE	PLAN SCALE 1" = _____
DWG.		DATE	PROF SCALE 1" = _____ HORIZ
R/W		DATE	SCALE 1" = _____ VERT

TOWN OF JAMES ISLAND
 CAMP ROAD SIDEWALK
 CONCEPT PLAN

RT. S-10-28 (CAMP ROAD)

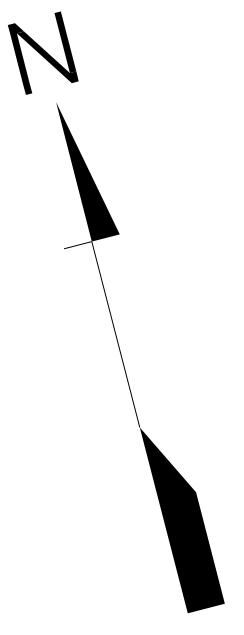
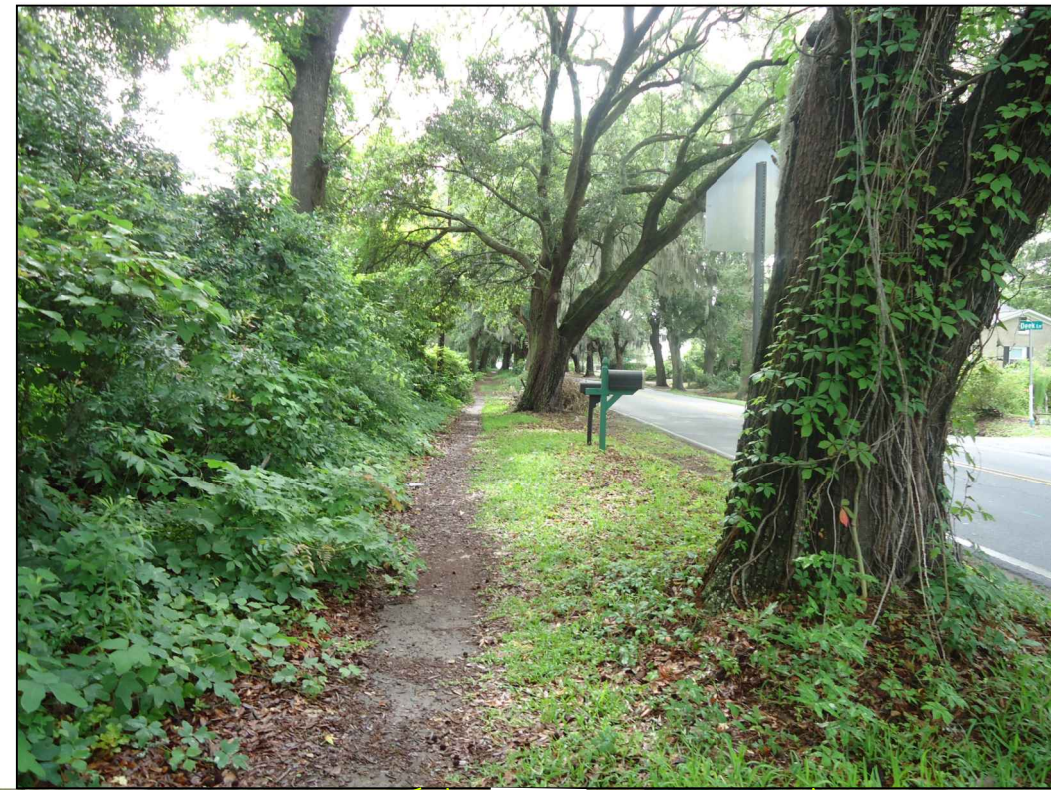

MATCH LINE
SEE SHEET 2

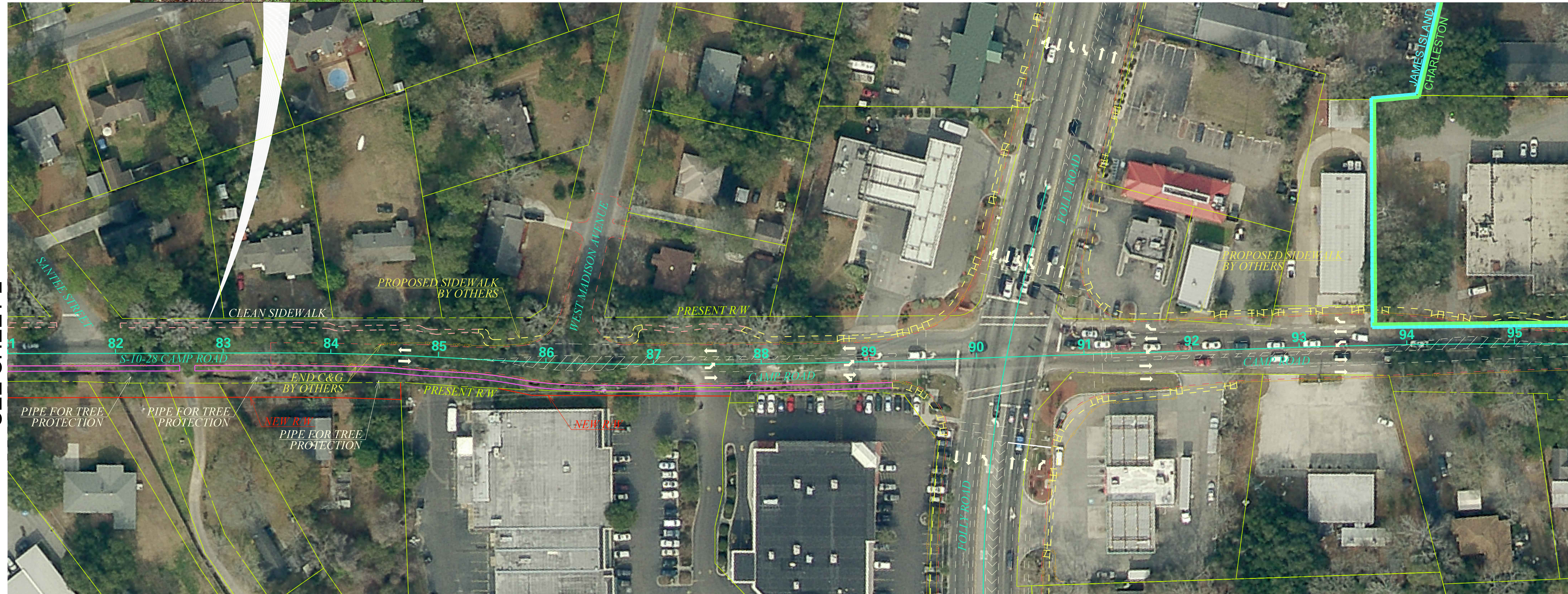

MATCH LINE
SEE SHEET 4

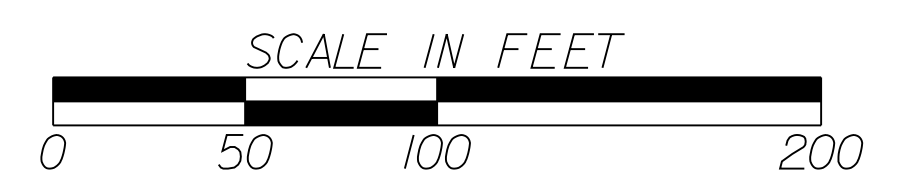

PLANS PREPARED BY:



Stantec Consulting
4969 Centre Pointe Drive, Suite 200
North Charleston, SC 29418
Tel. 843.740.7700
Fax. 843.740.7707
www.stantec.com

4			
3			
2			
1			
REV. NO.	BY	DATE	DESCRIPTION OF REVISION
TOPO.		DATE	PLAN SCALE 1" = _____
DWG.		DATE	PROF SCALE 1" = _____ HORIZ
R/W		DATE	SCALE 1" = _____ VERT

TOWN OF JAMES ISLAND

CAMP ROAD SIDEWALK
CONCEPT PLAN

RTE. S-10-28 (CAMP ROAD)

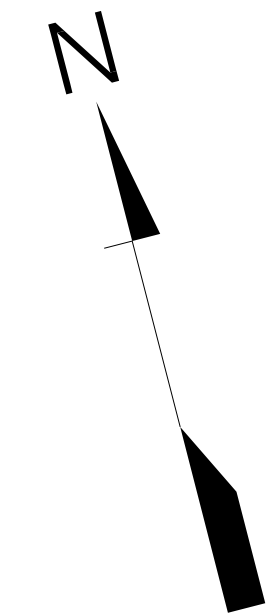

MATCH LINE
SEE SHEET 3

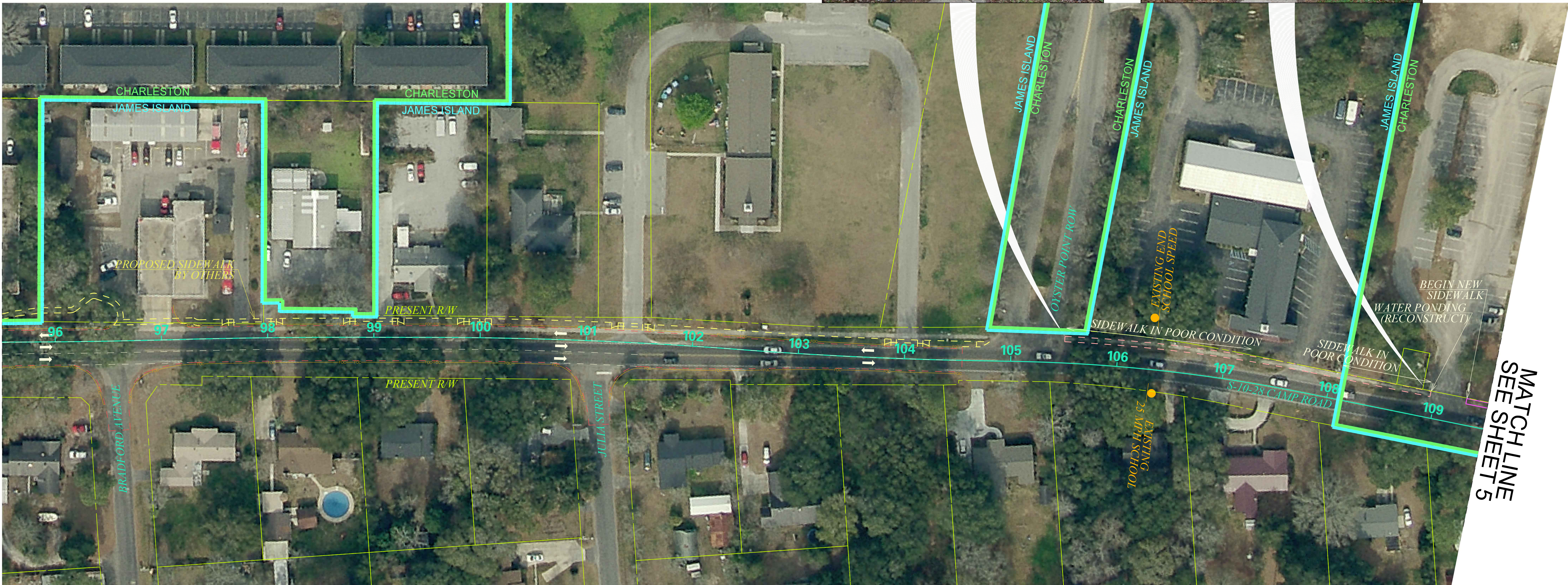

MATCH LINE
SEE SHEET 5

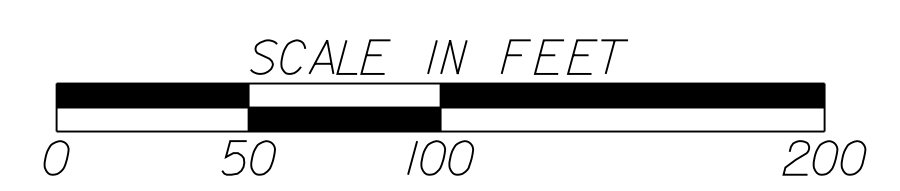

PLANS PREPARED BY:

 Stantec Consulting
 4969 Centre Pointe Drive, Suite 200
 North Charleston, SC 29418
 Tel. 843.740.7700
 Fax. 843.740.7707
 www.stantec.com

4			
3			
2			
1			
REV. NO.	BY	DATE	DESCRIPTION OF REVISION
TOPO.		DATE	PLAN SCALE 1" = _____
DWG.		DATE	PROF SCALE 1" = _____ HORIZ
R/W		DATE	SCALE 1" = _____ VERT

TOWN OF JAMES ISLAND
 CAMP ROAD SIDEWALK
 CONCEPT PLAN

RTE. S-10-28 (CAMP ROAD)

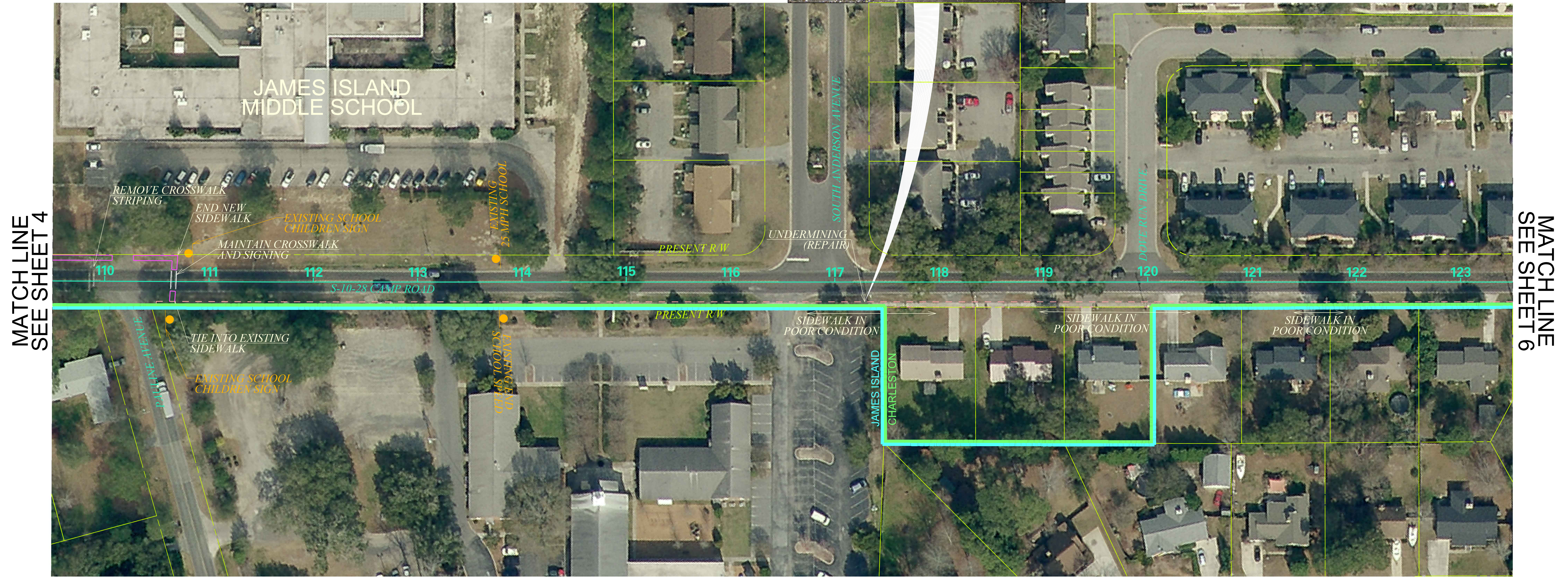
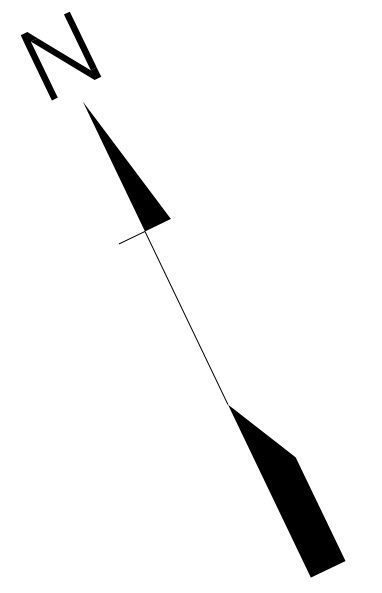

MATCH LINE
SEE SHEET 4

MATCH LINE
SEE SHEET 6

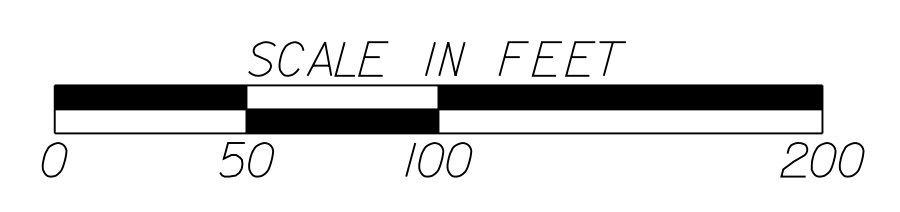

PLANS PREPARED BY:

 Stantec Consulting
 4969 Centre Pointe Drive, Suite 200
 North Charleston, SC 29418
 Tel. 843.740.7700
 Fax. 843.740.7707
 www.stantec.com

4			
3			
2			
1			
REV. NO.	BY	DATE	DESCRIPTION OF REVISION
TOPO.		DATE	PLAN SCALE 1" = _____
DWG.		DATE	PROF SCALE 1" = _____ HORIZ
R/W		DATE	SCALE 1" = _____ VERT

TOWN OF JAMES ISLAND
 CAMP ROAD SIDEWALK
 CONCEPT PLAN

RT. S-10-28 (CAMP ROAD)

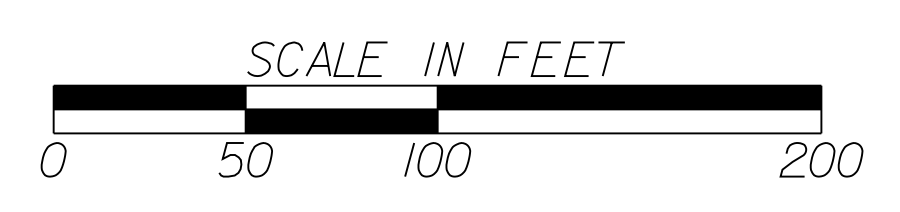
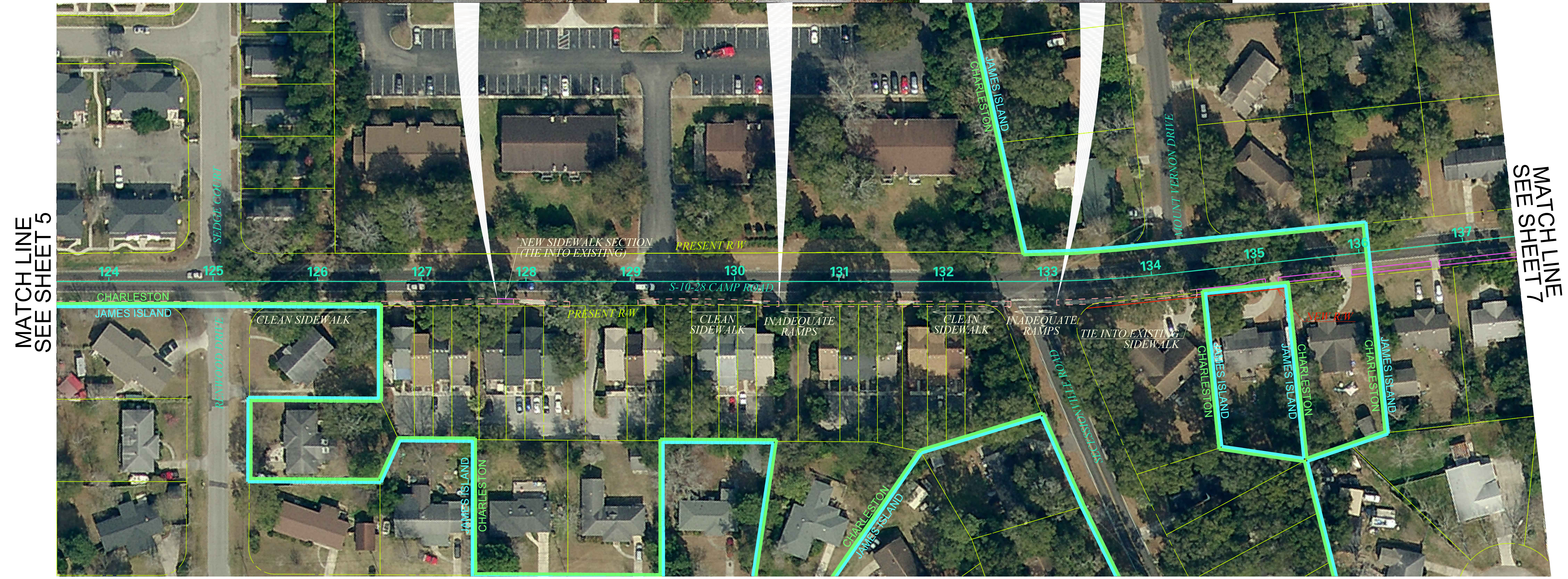
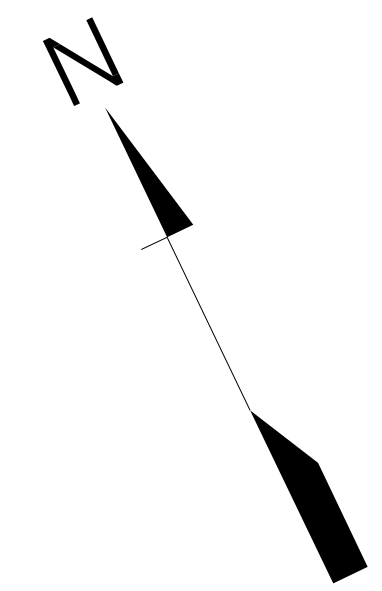

PLANS PREPARED BY:
Stantec
 Stantec Consulting
 4969 Centre Pointe Drive, Suite 200
 North Charleston, SC 29418
 Tel. 843.740.7700
 Fax. 843.740.7707
 www.stantec.com

4			
3			
2			
1			
REV. NO.	BY	DATE	DESCRIPTION OF REVISION
TOPO.		DATE	PLAN SCALE 1" = _____
DWG.		DATE	PROF SCALE 1" = _____ HORIZ
R/W		DATE	SCALE 1" = _____ VERT

TOWN OF JAMES ISLAND
 CAMP ROAD SIDEWALK
 CONCEPT PLAN

RT. S-10-28 (CAMP ROAD)

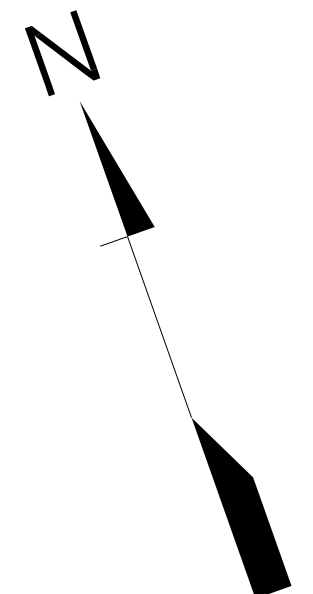

MATCH LINE
SEE SHEET 6

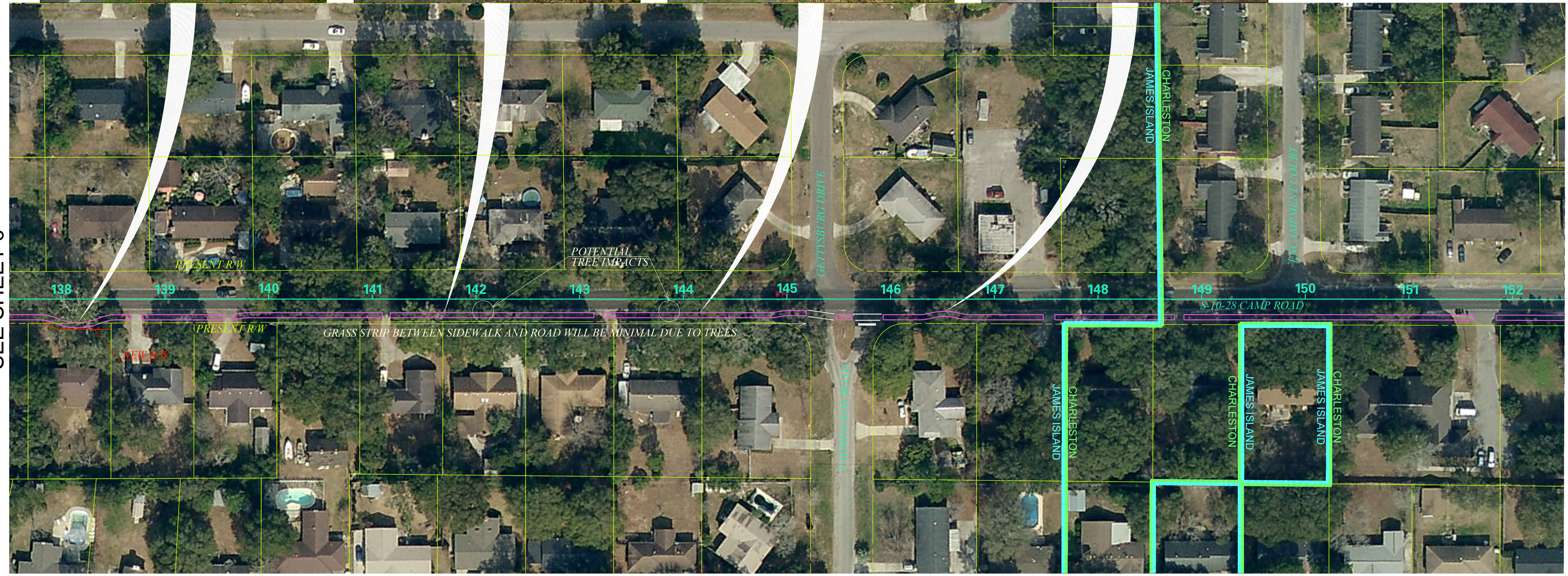

MATCH LINE
SEE SHEET 8

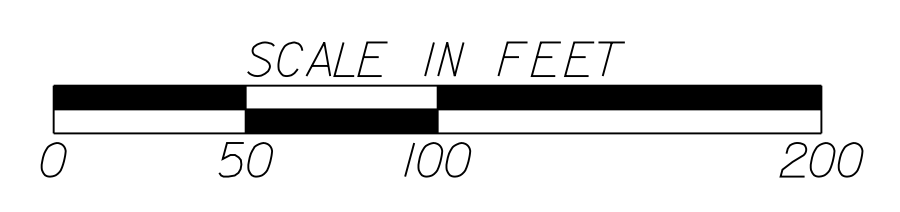

PLANS PREPARED BY:

 Stantec Consulting
 4969 Centre Pointe Drive, Suite 200
 North Charleston, SC 29418
 Tel. 843.740.7700
 Fax. 843.740.7707
 www.stantec.com

4			
3			
2			
1			
REV. NO.	BY	DATE	DESCRIPTION OF REVISION
TOPO.		DATE	PLAN SCALE 1" = _____
DWG.		DATE	PROF SCALE 1" = _____ HORIZ
R/W		DATE	SCALE 1" = _____ VERT

TOWN OF JAMES ISLAND
 CAMP ROAD SIDEWALK
 CONCEPT PLAN

RT. S-10-28 (CAMP ROAD)

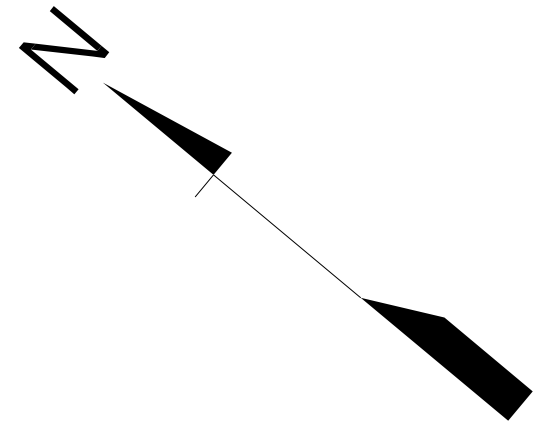

MATCH LINE
SEE SHEET 9

MATCH LINE
SEE SHEET 7

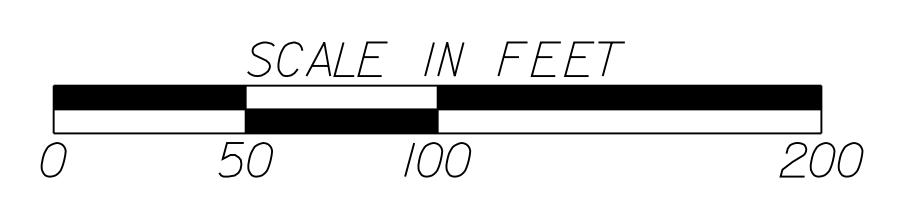

PLANS PREPARED BY:

 Stantec Consulting
 4969 Centre Pointe Drive, Suite 200
 North Charleston, SC 29418
 Tel. 843.740.7700
 Fax. 843.740.7707
 www.stantec.com

4			
3			
2			
1			
REV. NO.	BY	DATE	DESCRIPTION OF REVISION
TOPO.		DATE	PLAN SCALE 1" = _____
DWG.		DATE	PROF SCALE 1" = _____ HORIZ
R/W		DATE	SCALE 1" = _____ VERT

TOWN OF JAMES ISLAND
 CAMP ROAD SIDEWALK
 CONCEPT PLAN

RT. S-10-28 (CAMP ROAD)

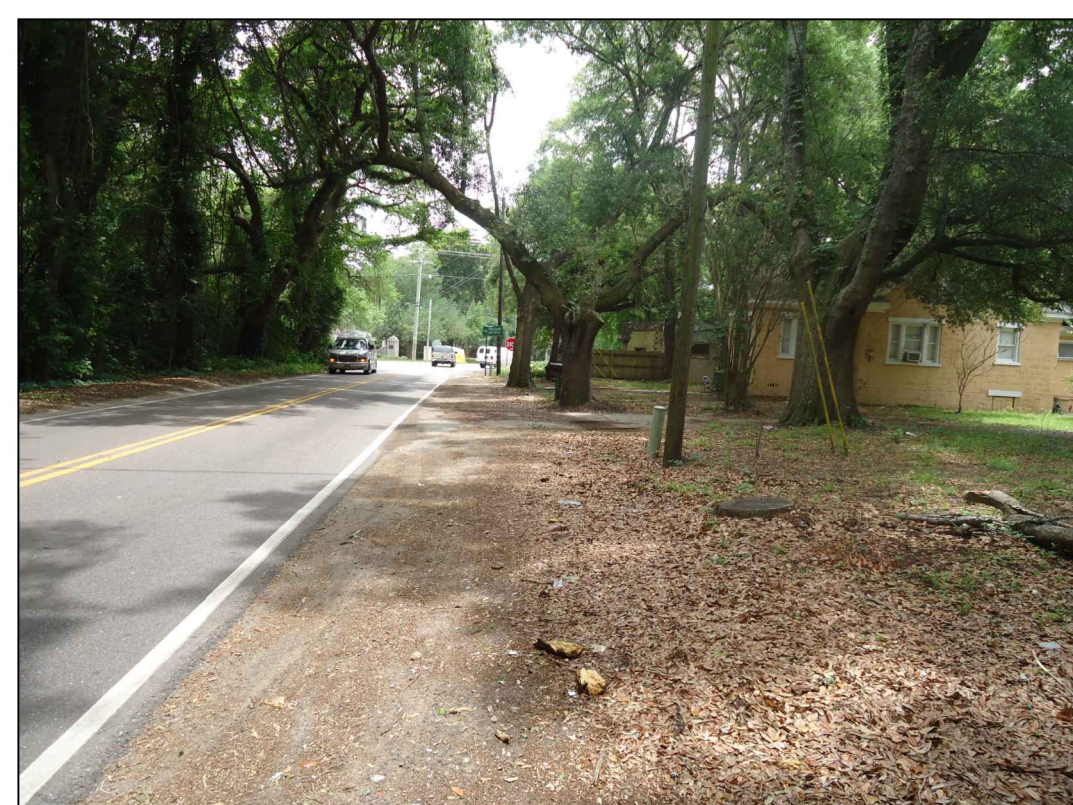
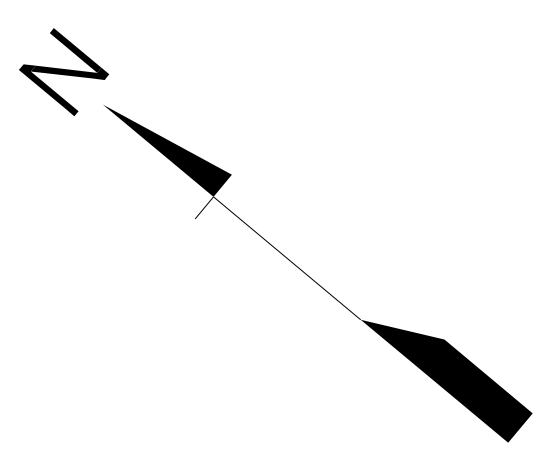

MATCH LINE
SEE SHEET 8

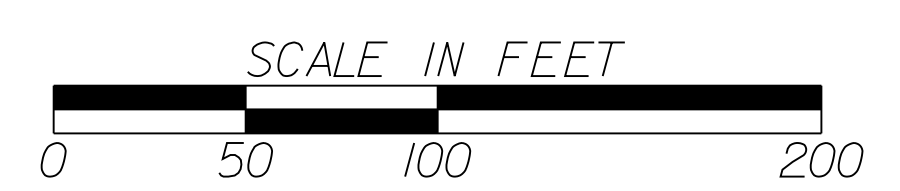
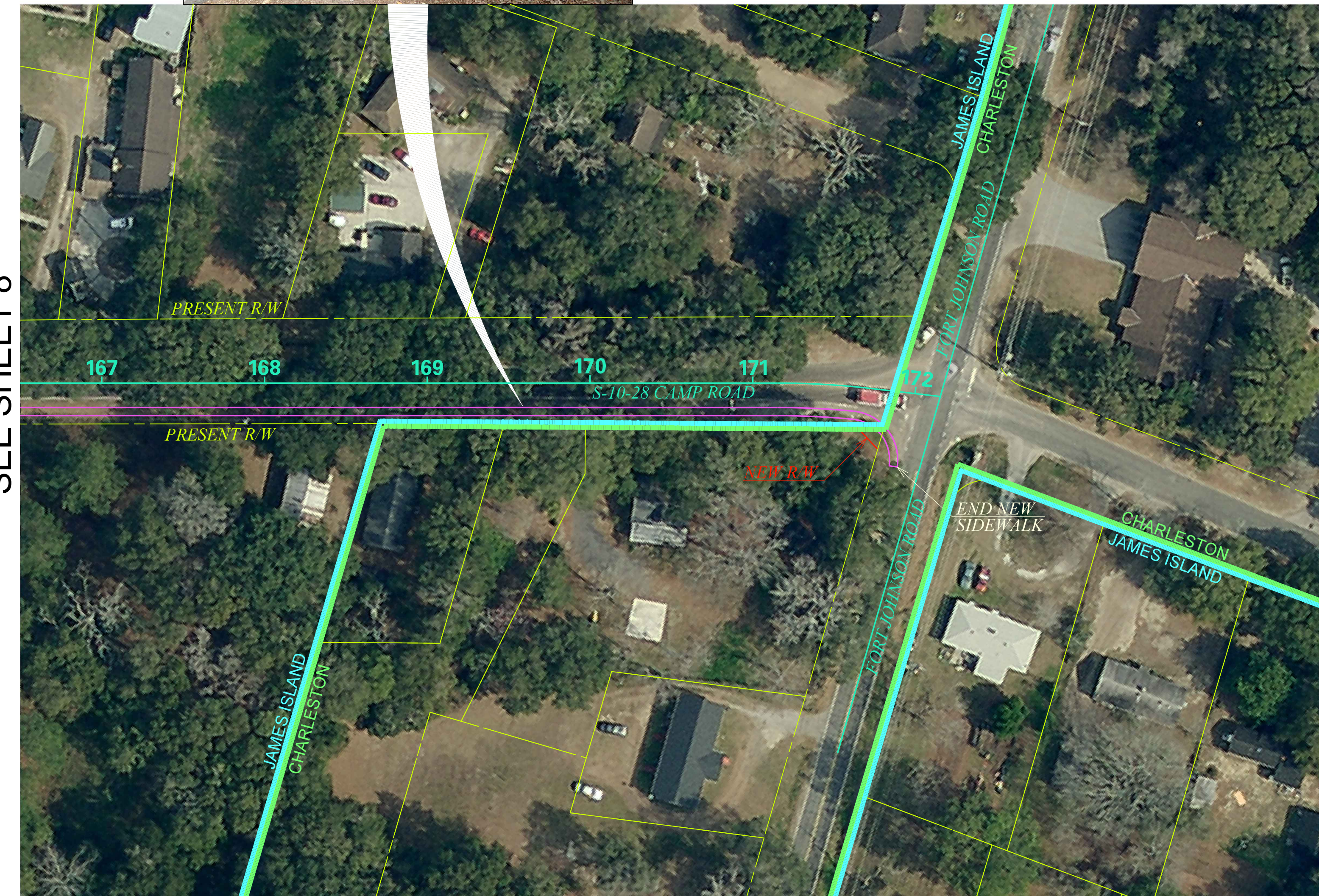

PLANS PREPARED BY:

 Stantec Consulting
 4969 Centre Pointe Drive, Suite 200
 North Charleston, SC 29418
 Tel. 843.740.7700
 Fax. 843.740.7707
 www.stantec.com

REV. NO.	BY	DATE	DESCRIPTION OF REVISION
4			
3			
2			
1			
TOPO.		DATE	PLAN SCALE 1" = _____
DWG.		DATE	PROF SCALE 1" = _____ HORIZ
R/W		DATE	SCALE 1" = _____ VERT

TOWN OF JAMES ISLAND
 CAMP ROAD SIDEWALK
 CONCEPT PLAN

RTE. S-10-28 (CAMP ROAD)